



ME2-C2H5OH-Φ16

Electrochemical Alcohol Sensor

Manual V1.2
(Model: ME2-C2H5OH-Φ16)

Zhengzhou Winsen Electronics Technology Co., Ltd

ME2-C2H5OH-Φ16 Alcohol sensor

ME2-C2H5OH-Φ16 electrochemical sensor detect gas concentration by measuring current based on the electrochemical principle, which utilizes the electrochemical oxidation process of target gas on the working electrode inside the electrolytic cell, the current produced in electrochemical reaction of the target gas are in direct proportion with its concentration while following Faraday law, then concentration of the gas could be get by measuring value of current.

1.Features

- * Low consumption
- * High precision
- * High sensitivity
- * Wide linear range
- * Good anti-interference ability
- * Excellent repeatability and stability



2 Application

Widely used for public traffic ,environmental protection alcohol detection.

3. Technical Parameter

Item	Parameter
Detection gas	C2H5OH Alcohol
Measurement Range	(0~1.0) mg/L
Max detecting concentration	2.0 mg/L
Sensitivity	(6±2) μA/(mg/L)
Response time (T ₉₀)	≤20S
Load resistance (recommend)	10Ω
Repeatability	±0.006mg/L
Stability (/ month)	<2%
Output Linearity	linear
Zero drift (-20℃ ~40℃)	-0.01 mV~0.01mV
Storage temperature	0℃ ~20℃
Humidity Range	15% ~90% RH
Temperature Range	-20℃~50℃
Pressure range	Standard atmosphere±10%
Anticipated using life	2 years(in air)

4. External dimension

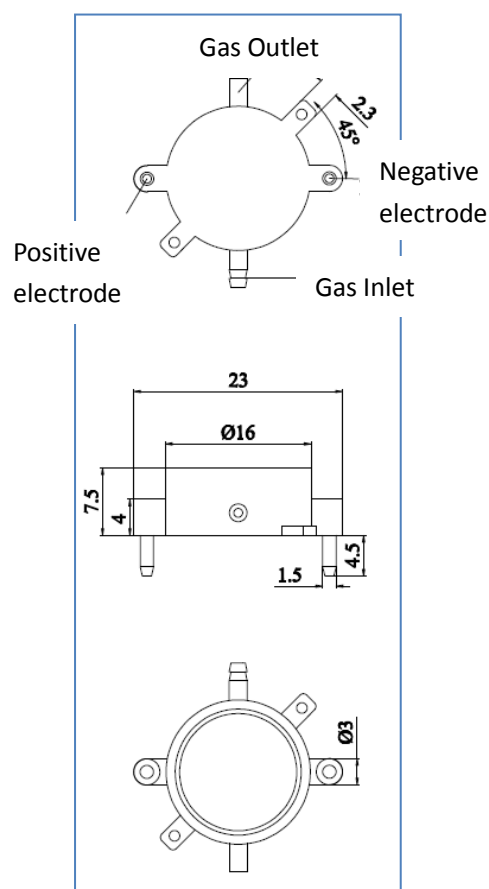

5. Basic circuit

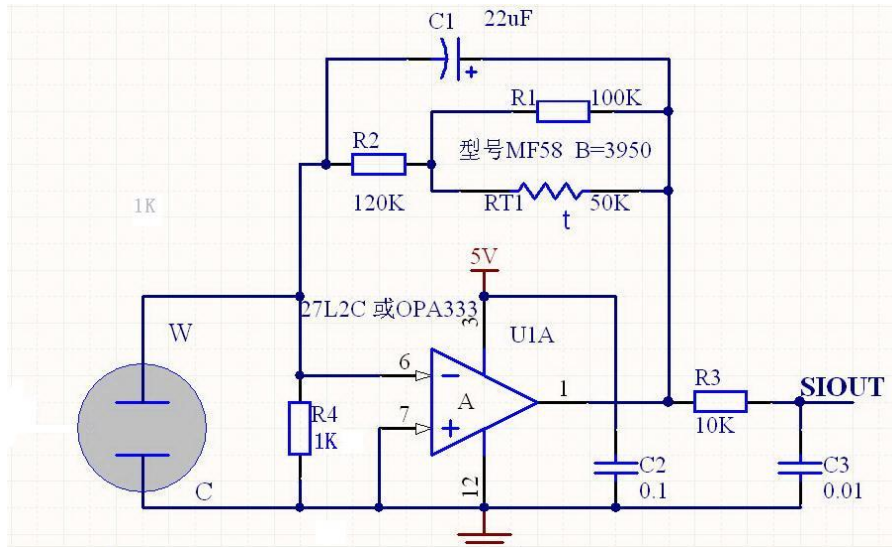

6. Characterization

Features of Sensitivity, response and output signal

Data graph of concentration linearity features

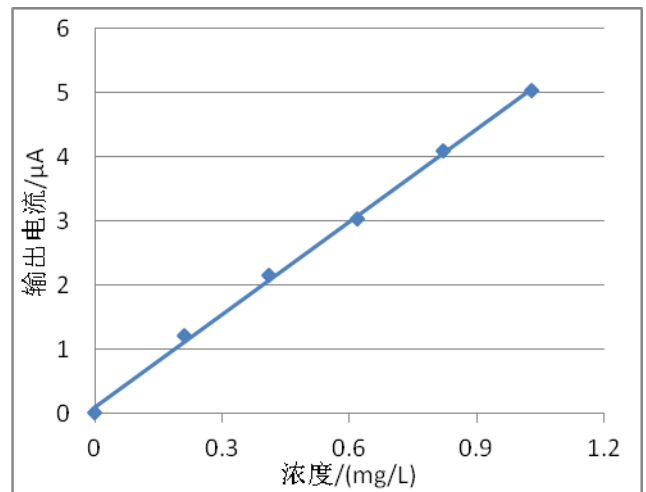
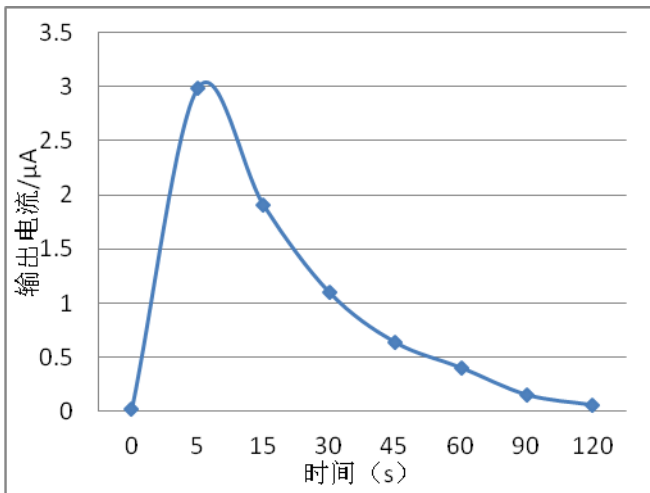

V0 Change upon Variable Temperature

Sensitivity upon variable temperature

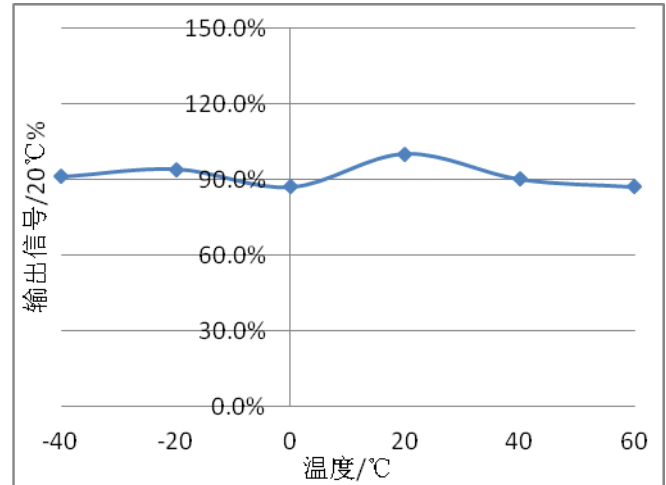
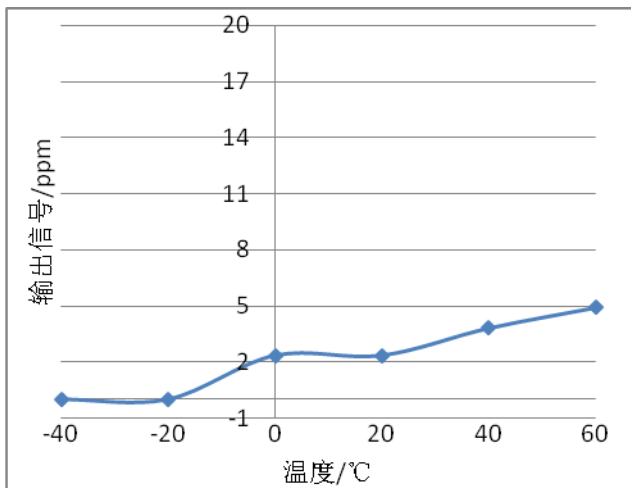

7. Connection of sensor and pump

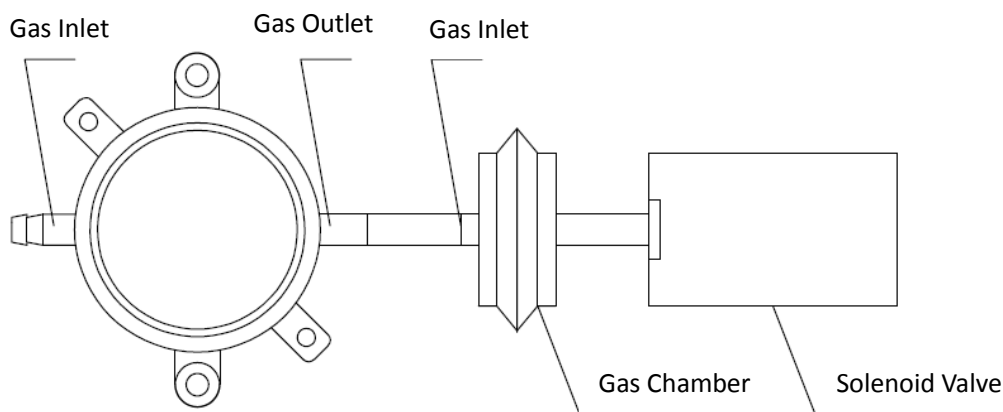

Electromagnetic pump includes gas chamber and solenoid valve.

8. Application Notes:

- Sensor shall Avoid organic solvent, coatings, medicine, oil and high concentration gases;
- All ME Sensors shall not be encapsulated completely by resin materials, and shall not immerse in pure oxygen environment, otherwise, it will damage the function of sensor;
- All ME sensors shall not be applied in corrosive gas environment, or the sensor will be damaged;
- Please test the sensitivity of gas sensors in clean atmosphere;
- Sensors Shall be avoided to face the gas, which flow directly from front side;
- To avoid to bend and break of pins;
- Blowhole of the sensor should not be blocked and polluted, which will cause the sensitivity decrease;
- Excessive impact or vibration should be avoided;
- Do not use the sensor when the shell is damaged;
- It takes some time for the sensor to return to normal state After applied in high concentration gas;
- Do not take apart the sensor, otherwise electrolyte leakage can cause sensor damage;
- Working electrode and reference electrode of the sensor shall be in short circuit when stored.;
- To preheat over 48hs before using and soldering forbidden;

Note: To keep continual product development, we reserve right to change design features without prior notice !

Zhengzhou Winsen Electronics Technology Co., Ltd

Add.: NO.299 Jin Suo Road, National Hi-Tech Zone,
Zhengzhou, 450001 China

Tel.: 0086-371-67169097 67169670

E-mail: sales@winsensor.com