



Flammable Gas Sensor

(Model: MP-5)

Manual

Version: 1.5

Valid from: 2021-07-17

Zhengzhou Winsen Electronics Technology Co., Ltd

Statement

This manual copyright belongs to Zhengzhou Winsen Electronics Technology Co., LTD. Without the written permission, any part of this manual shall not be copied, translated, stored in database or retrieval system, also can't spread through electronic, copying, record ways.

Thanks for purchasing our product. In order to let customers use it better and reduce the faults caused by misuse, please read the manual carefully and operate it correctly in accordance with the instructions. If users disobey the terms or remove, disassemble, change the components inside of the sensor, we shall not be responsible for the loss.

The specific such as color, appearance, sizes &etc, please in kind prevail.

We are devoting ourselves to products development and technical innovation, so we reserve the right to improve the products without notice. Please confirm it is the valid version before using this manual. At the same time, users' comments on optimized using way are welcome.

Please keep the manual properly, in order to get help if you have questions during the usage in the future.

Zhengzhou Winsen Electronics Technology CO., LTD.

MP-5 Flammable Gas Sensor

Profile

MP-5 gas sensor is for flammable gases. It adopts multilayer thick film manufacturing technology. The heater and metal oxide semiconductor material on the ceramic substrate of Al_2O_3 are fetched out by electrode down-lead, encapsulated in metal socket and cap. Conductivity of the sensor is affected by the concentration of target gas. The higher the concentration is, the higher conductivity of sensor gets. Users can adopt simple circuit to convert variation of conductivity into output signal corresponding to gas concentration.

Features:

- * Lower consumption
- * Small size
- * Fast response and resume
- * Highest sensitivity
- * Excellent stability and long life
- * Easy circuit and big signal output
- * Excellent selectivity

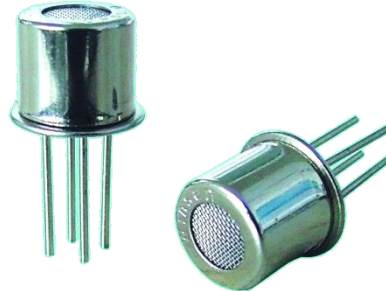

Application

It is widely used in domestic gas leakage alarm, industrial flammable gas alarm and portable gas detector.

Technical Parameters

Model		MP-5	
Sensor Type		Flat surfaced semiconductor sensor	
Standard Encapsulation		Metal cap	
Target Gas		LPG	
Detection range		300-10000ppm LPG	
Standard Circuit Conditions	Loop Voltage	V_c	$\leq 24V$ DC
	Heater Voltage	V_H	$5V \pm 0.1V$ AC or DC
	Load Resistance	R_L	Adjustable
Sensor character under standard test conditions	Heater Resistance	R_H	$85\Omega \pm 15\Omega$ (room temp.)
	Heater consumption	P_H	$\leq 300mW$
	Sensitivity	S	$R_o(\text{in air})/R_s(2000ppm C_3H_8) \geq 5$
	Sensitive resistance	R_s	$1K\Omega \sim 20K\Omega$ (in 2000ppm C_3H_8)
	Concentration Slope	α	$\leq 0.6(R_{2000ppm}/R_{500ppm} C_3H_8)$
Standard test conditions	Tem. Humidity	$20^\circ C \pm 2^\circ C$; $65\% \pm 5\%RH$	
	Standard test circuit	$V_c: 5V \pm 0.1V$; $V_H: 5V \pm 0.1V$	
	Preheat time	Not less than 48 hours	
	O ₂ content	21% (not less than 18%) O ₂ concentration effects initial value, sensitivity and repeatability.	
Lifespan		10 years	

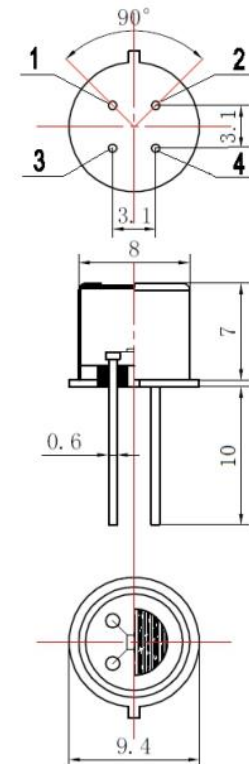
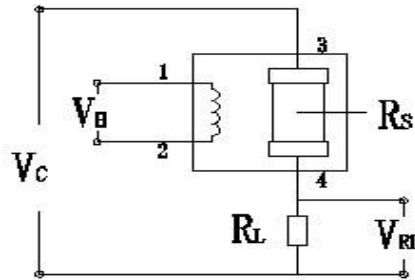

Fig1. Sensor structure

Basic circuit



Instructions: The above fig is the basic test circuit of MP-5. The sensor requires two voltage inputs: heater voltage (V_H) and circuit voltage (V_C). V_H is used to supply standard working temperature to the sensor and it can adopt DC or AC power, while V_{RL} is the voltage of load resistance R_L which is in series with sensor. V_C supplies the detect voltage to load resistance R_L and it should adopt DC power.

Description of Sensor Characters

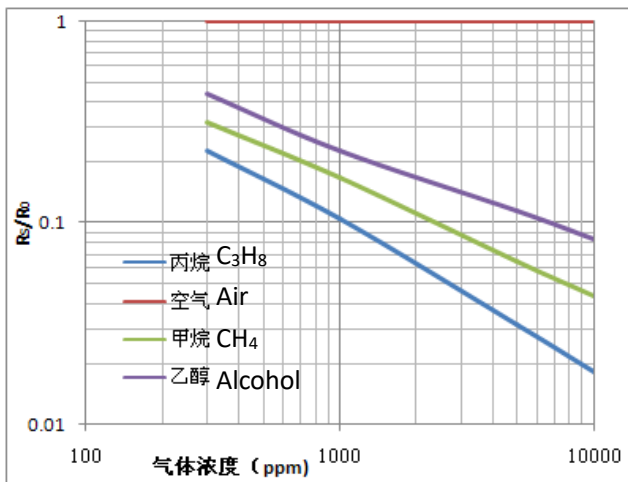

Fig3. Typical Sensitivity Curve

The ordinate is resistance ratio of the sensor (R_s/R_0), the abscissa is concentration of gases. R_s means resistance in target gas with different concentration, R_0 means resistance of sensor in clean air. All tests are finished under standard test conditions.

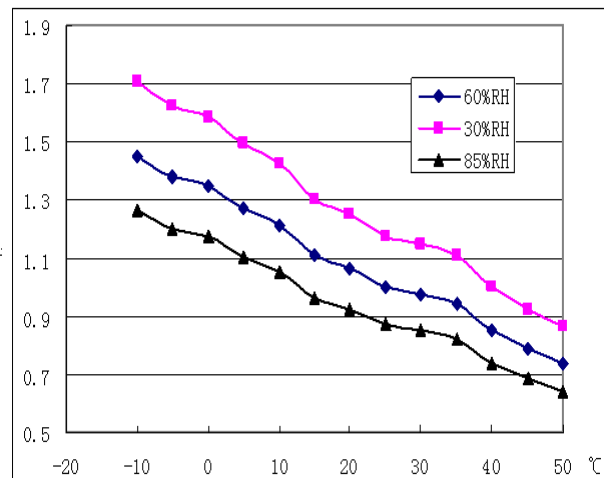

Fig4. Typical temperature/humidity characteristics

The ordinate is resistance ratio of the sensor (R_s/R_{s0}). R_s means resistance of sensor in 2000ppm propane (C_3H_8) under different tem. and humidity. R_{s0} means resistance of the sensor in 2000ppm propane (C_3H_8) under 20°C /65%RH.

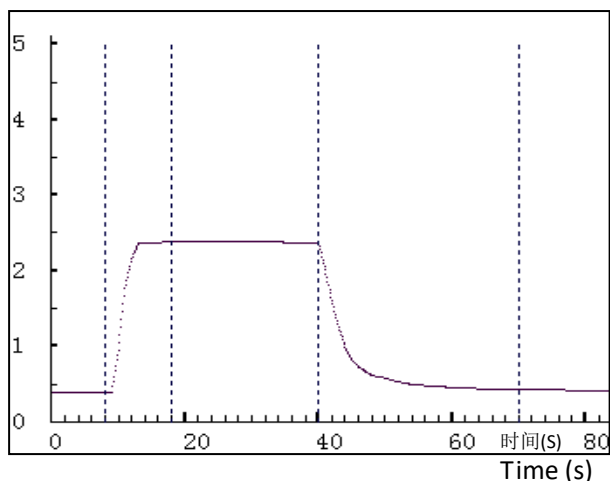

Fig5. Response and Resume

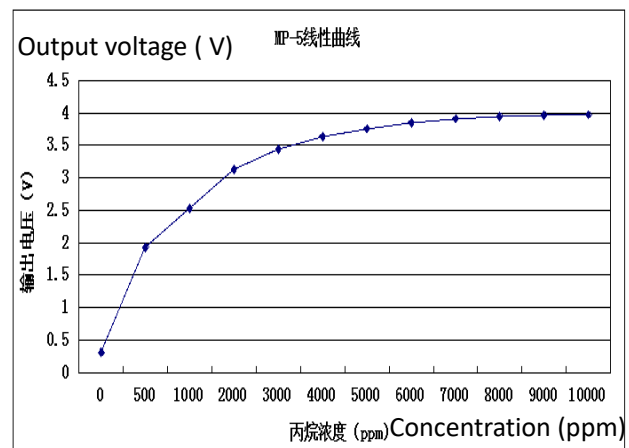
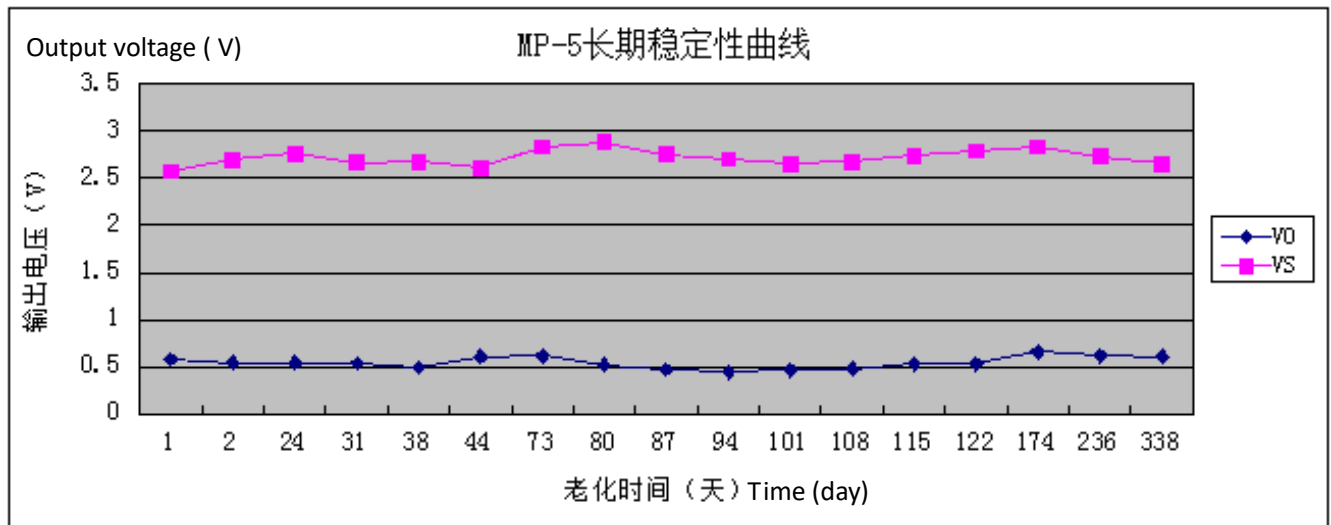

Fig6. Linearity curve



Long-term Stability

Test is finished in standard test conditions, the abscissa is observing time and the ordinate is V_{RL} .

Cautions

1 .Following conditions must be prohibited

1.1 Exposed to volatilizable organic silicon steam

Sensing material will lose sensitivity and never recover if the sensor absorbs organic silicon steam. Sensors must be avoided exposing to silicon bond, fixture, silicon latex, putty or plastic contain silicon environment.

1.2 High Corrosive gas

If the sensors are exposed to high concentration corrosive gas (such as H_2S , SO_x , Cl_2 , HCl etc.), it will not only result in corrosion of sensors structure, also it cause sincere sensitivity attenuation.

1.3 Alkali, Alkali metals salt, halogen pollution

The sensors performance will be changed badly if sensors be sprayed polluted by alkali metals salt especially brine, or be exposed to halogen such as fluorine.

1.4 Touch water

Sensitivity of the sensors will be reduced when spattered or dipped in water.

1.5 Freezing

Do avoid icing on sensor's surface, otherwise sensing material will be broken and lost sensitivity.

1.6 Applied higher voltage

Applied voltage on sensor should not be higher than stipulated value, even if the sensor is not physically damaged or broken, it causes down-line or heater damaged, and bring on sensors' sensitivity characteristic changed badly.

1.7 Voltage on wrong pins

As Fig8. Pin 1&2 connects to heater circuit, Pin 3&4 connects to measuring circuit; Under the requested conditions, heating and measuring can use the same power circuit.

NOTE: the two pins near the protuberance mark is heating electrode.

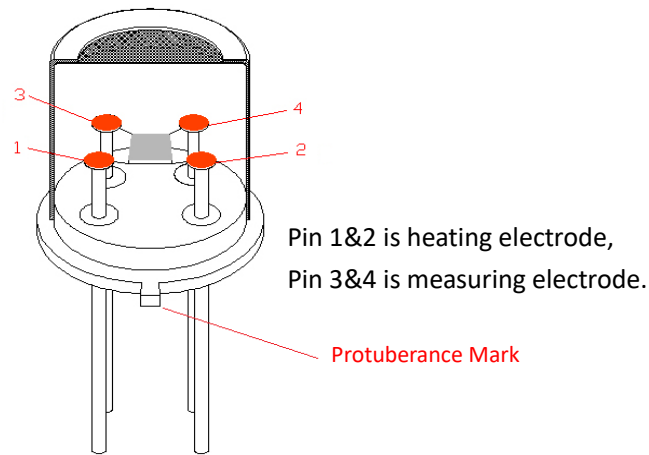

Fig8.Pin Schematic Diagram

2 .Following conditions should be avoided

2.1 Water Condensation

Indoor conditions, slight water condensation will influence sensors' performance lightly. However, if water condensation on sensors surface and keep a certain period, sensors' sensitive will be decreased.

2.2 Used in high gas concentration

No matter the sensor is electrified or not, if it is placed in high gas concentration for long time, sensors characteristic will be affected. If lighter gas sprays the sensor, it will cause extremely damage.

2.3 Long time storage

The sensors resistance will drift reversibly if it's stored for long time without electrify, this drift is related with storage conditions. Sensors should be stored in airproof bag without volatile silicon compound. For the sensors with long time storage but no electrify, they need long galvanical aging time for stability before using. The suggested aging time as follow:

Stable2.

Storage Time	Suggested aging time
Less than one month	Not less than 48 hours
1 ~ 6 months	Not less than 72 hours
More than six months	Not less than 168 hours

2.4 Long time exposed to adverse environment

No matter the sensors electrified or not, if exposed to adverse environment for long time, such as high humidity, high temperature, or high pollution etc., it will influence the sensors' performance badly.

2.5 Vibration

Continual vibration will result in sensors down-lead response then break. In transportation or assembling line, pneumatic screwdriver/ultrasonic welding machine can lead this vibration.

2.6 Concussion

If sensors meet strong concussion, it may lead its lead wire disconnected.

2.7 Usage Conditions

2.7.1For sensor, handmade welding is optimal way. The welding conditions as follow:

- Soldering flux: Rosin soldering flux contains least chlorine
- homothermal soldering iron
- Temperature: $\leq 350^{\circ}\text{C}$
- Time: less than 3 seconds

If disobey the above using terms, sensors sensitivity will be reduced.

Zhengzhou Winsen Electronics Technology Co., Ltd

Add: No.299, Jinsuo Road, National Hi-Tech Zone,

Zhengzhou 450001 China

Tel: +86-371-67169097/67169670

Fax: +86-371-60932988

E-mail: sales@winsensor.com

Website: www.winsen-sensor.com

