



Pyroelectric Flame Sensor (Model: RD-913FB3)

User's Manual

Version: 2.0

Valid from: 2020-10

Zhengzhou Winsen Electronics Technology Co., Ltd

Statement

This manual copyright belongs to Zhengzhou Winsen Electronics Technology Co., LTD. Without the written permission, any part of this manual shall not be copied, translated, stored in database or retrieval system, also can't spread through electronic, copying, record ways.

Thanks for purchasing our product. In order to let customers use it better and reduce the faults caused by misuse, please read the manual carefully and operate it correctly in accordance with the instructions. If users disobey the terms or remove, disassemble, change the components inside of the sensor, we shall not be responsible for the loss.

The specific such as color, appearance, sizes &etc, please in kind prevail.

We are devoting ourselves to products development and technical innovation, so we reserve the right to improve the products without notice. Please confirm it is the valid version before using this manual. At the same time, users' comments on optimized using way are welcome.

Please keep the manual properly, in order to get help if you have questions during the usage in the future.

Zhengzhou Winsen Electronics Technology CO., LTD.

RD-913FB3 Pyro-electric Flame sensor

RD-913FB3 pyro-electric flame sensor uses lithium tantalate single crystal as the sensitive element material. The Curie temperature of lithium tantalate crystal material is above 600°C, the relative dielectric constant is small, and the specific detectivity is high.

In a wide range of room temperature, the pyroelectric coefficient of the material changes very little with temperature, and the temperature change rate of the output signal is only 1-2%. The temperature stability of the sensor performance is very good, and the spectral response consistency is very good in the wavelength range of 1-20um.



Features:

- * 5.0um detection band;
- * TO-5 package, single channel, voltage mode;
- * Low microphone effect, large FOV, high detection rate;
- * Detection band measurement of flame signal;

Applications:

It's widely used in various oil storage stations, large warehouses, factory workshops, forests, charging piles; and standard configuration for high fire risk areas such as petroleum, chemical, paper-making, forests, and garages.

It also becomes popular in high-end residential, commercial, and general industrial fields.

Size(Unit:mm)

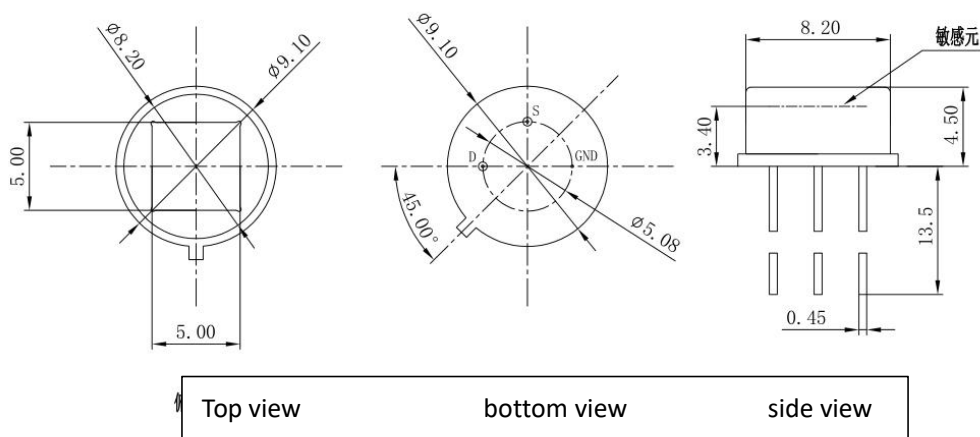

Parameters

Table 1

Item	Typical	Unit
Window Size	5.0*5.0	mm
Sensitive element size	Φ2.5	mm
Filter center wavelength	5.0	um
Electrical time constant	5	s
Thermal time constant	200	ms
Source Voltage	0.4~0.7	v
Working Voltage	2~15	v
Recommended voltage	3~5	v
Output signal V0 (500K,10HZ,25°C)	2.8±10%	v
Output noise voltage VN (10HZ, BW1HZ, 25°C)	≤150	mv
Voltage response rate (no window) Rv (500K, 10HZ, 25°C)	≥500	v/w
Specific detection rate (no window) D* (500K, 10HZ, BW1HZ, 25°C)	≥5×10 ⁸	cmHz ^{1/2} /W
Field of view(FOV)	>115	°
Detection distance	35~50	m
Working temperature	-30~+75	°C
Storage temperature	-40~+80	°C
Remarks: The magnification of the testing machine is 80dB.		

Internal circuit

Sensor 1 pin Vd is the drain of the field effect transistor, and voltage is applied; pin 2 Vs is the output signal; pin 3 GND is grounded.

Lithium tantalate sheet and a high resistance Rg form a parallel circuit, and then connect to the gate of the field effect transistor.

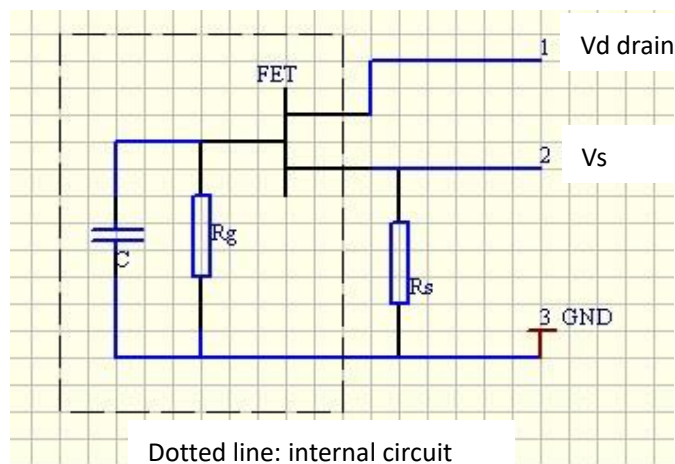

Testing circuit

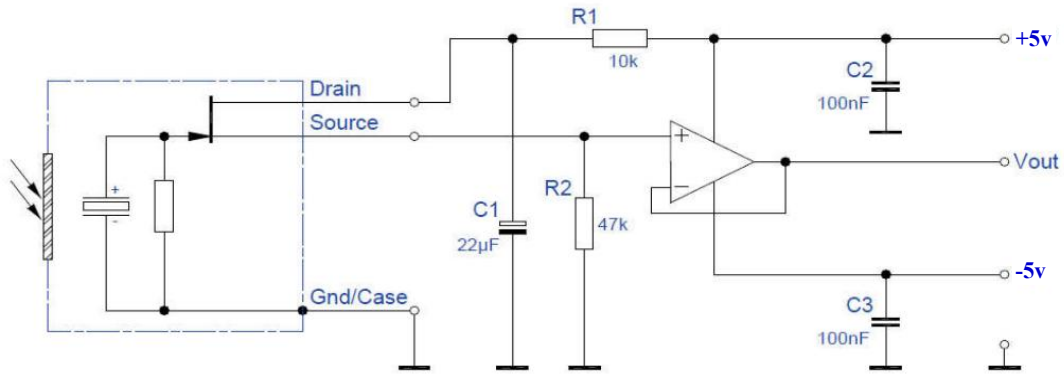

Application circuit

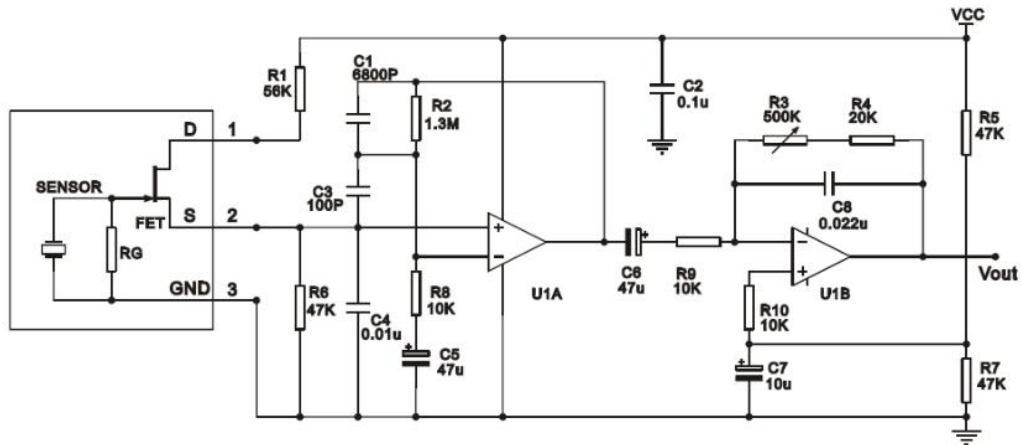

Filter parameters

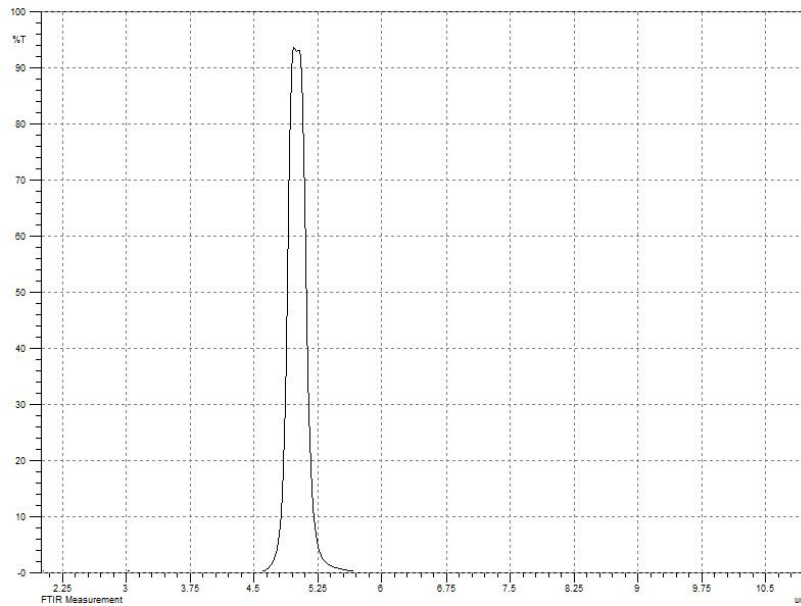

5.0µm narrow band filter spectral curve

Filter parameters of commonly used sensor models:

Part No.	RD-913FB1	RD-913FB2	RD-913FB3	RD-913FB4	RD-913FB5
Center wavelength (nm)	3800±40	4300±50	5000±40	4400±40	4450±40
Full width at half maximum FWHM (nm)	180±20	600±40	240±20	400±20	300±20
Transmittance (%)	>90%	>90%	>90%	>90%	>85%

Notes:

- (1) Pyroelectric infrared sensors are piezoelectric and are very sensitive to sound, electromagnetic waves and vibration. When using pyroelectric infrared sensors, proper shock absorption and shielding are necessary.
- (2) In order to avoid turbulent air flow and crosstalk, which may cause false alarms, when the sensor is used in the design of the flame detector, window protection (such as white sapphire, calcium fluoride or infrared glass, etc.) must be added.
- (3) When welding the pyroelectric infrared sensor, it is recommended to solder at a position above 3mm. When using a soldering iron for manual soldering, the temperature of the soldering iron tip should be controlled below 350°C, and the soldering time for each location is less than 3 seconds, and the tube should be clamped with tweezers, to prevent damage to the electronic components under high temperature conditions.
- (4) During the installation and use of the pyroelectric infrared sensor, prevent the sensor components from falling. The sensor should be stored in a dry environment.
- (5) When operating the pyroelectric infrared sensor, the temperature of the pyroelectric infrared sensor is changed due to hand contact, especially through welding. Therefore, when the sensor is working again, it is necessary to wait for a period of time. After the temperature of the sensor is balanced, resume normal work.
- (6) Do not touch the sensor window directly with your hands and hard objects. Keep the window clean. When there is dirt, use an alcohol cotton ball to gently wipe it clean.
- (7) When installing the sensor, it is forbidden to apply mechanical pressure to prevent damage to the sensor's sensitive elements, windows and other components due to the existence of pressure.
- (8) When the sensor is taken out from the packaging box, and during measuring and installing, it must be equipped with electrostatic protection tools. The electrostatic protection requirement is less than 2000V to prevent the high voltage from breaking down the field effect tube of the sensor.

Note: To keep continual product development, we reserve the right to change design features without prior notice.

Zhengzhou Winsen Electronics Technology Co., Ltd

Add: No.299, Jinsuo Road, National Hi-Tech Zone,
Zhengzhou 450001 China

Tel: +86-371-67169097/67169670

Fax: +86-371-60932988

E-mail: sales@winsensor.com

Website: www.winsen-sensor.com