



**Electrochemical
Carbon Monoxide Sensor
(Model: MEu-CO)**

Manual

Version:1.1

Issue Date:2021-5-19

Zhengzhou Winsen Electronic Technology Co., Ltd

Statement

This manual copyright belongs to Zhengzhou Winsen Electronics Technology Co., LTD.
Without the

written permission, any part of this manual shall not be copied, translated, stored in
database or

retrieval system, also can't spread through electronic, copying, record ways.

Thanks for purchasing our product. In order to let customers use it better and reduce the
faults caused by misuse, please read the manual carefully and operate it correctly in
accordance with the instructions. The data provided in this manual is obtained under the
conditions of 20°C, 50%RH and 1atm. This data is the data obtained by the test system of
Winsen in the initial stage after the manufacture of the sensor. This data is for reference
only.

If users disobey the terms or remove, disassemble, change the components inside of the
sensor, we shall not be responsible for the loss.

The specific such as color, appearance, sizes &etc, please in kind prevail.

We are devoting ourselves to products development and technical innovation, so we reserve
the right to improve the products without notice. Please confirm it is the valid version before
using this manual. At the same time, users' comments on optimized using way are welcome.

Please keep the manual properly, in order to get help if you have questions during the usage
in the future.

Zhengzhou Winsen Electronics Technology CO., LTD

MEu-CO Carbon Monoxide Sensor

Description

The MEu-CO sensor is a fuel cell sensor. Carbon monoxide and oxygen undergo a corresponding oxidation-reduction reaction on the working electrode and counter electrode and release charges to form a current. The current generated is proportional to the concentration of carbon monoxide and follows Faraday's law. The size can determine the concentration of carbon monoxide.



Features

* Excellent repeatability and stability

Application

CO detection in industrial occasions like petroleum, petrochemical, metallurgy, mining and environmental fields.

Portable carbon monoxide detection instrument

Fixed point carbon monoxide detector

Technical parameter

Table 1

Item	Parameter
Detection gas	Carbon monoxide(CO)
Measurement Range	0~1000ppm
Max Range	2000ppm
Sensitivity	(0.085±0.015) nA/ppm
Response time (T ₉₀)	<15S
Zero point output (in clean)	<±2ppm(Equivalent CO)
Zero drift (-40℃~ + 50℃)	< + 10ppm(Equivalent CO)
Repeatability	<±3% output value
Linearity	Within ±5%
Stability	<2%
Filter	Acid gas, organic vapor

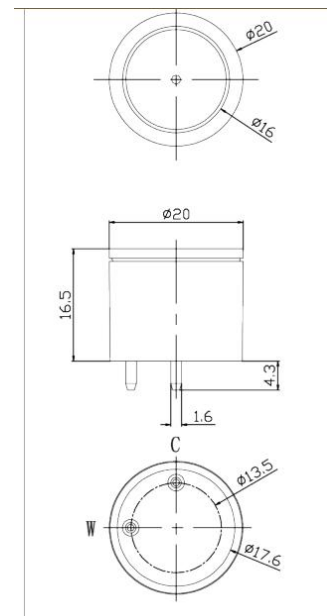

Figure 1: Sensor structure diagram;Unit:mm, Error±0.15mm

Working Environment

Table 2

Item		Parameter
Range of working temperature	Continue working	-20°C ~ + 40°C
	Intermittent working	-40°C ~ + 55°C
Working humidity range		15%RH ~ 90%RH(No condensation)
Working pressure range		1atm ± 10%

Lifespan

Table 3

Item	Parameter
Long-term output drift	<5%/Year
Recommended storage environment	+10°C ~ + 30°C
Expected service life	3 Years(in the air)
Storage time	Original package ≤ 6 months

Cross interference

In addition to the target gas, the MEu-CO sensor also responds to other gases. The data in the table are the typical response of common interfering gases at a given concentration and the equivalent value of carbon monoxide. The sensor also responds to certain gases not listed in the table below, and the sensor and equipment should be used according to the actual application scenario.

Table 4 Cross Interference Data Sheet

Gas	Concentration (ppm)	Equivalent CO concentration(ppm)
H2S	100	0
SO2	20	0
H2	200	25
C2H4	100	100

Cautions

- The pins(sockets) connector provided by the manufacturer should be used during installation, and direct welding of the tube pin is prohibited;
- The aging time before use is not less than 48 hours;
- Before using the sensor (portable meter) and in use (fixed point detector), confirm that it is in a normal state;
- Long-term use in an over-range high-concentration gas environment can cause damage to the sensor;
- The pin of the tube must not be broken or bent;
- The sensor must not be subjected to excessive shock or vibration;
- Do not disassemble the sensor at will. Disassembling the sensor will cause electrolyte leakage and cause harmful consequences;
- Damage to the casing will cause liquid leakage, do not use in this case;
- Avoid contact with organic solvents (including silicone rubber and other adhesives), coatings, pharmaceuticals, fuel oils and high-concentration gases;
- All electrochemical sensors cannot be completely encapsulated with resin materials or immersed in an oxygen-free environment, otherwise the performance of the sensor will be damaged;
- It is forbidden to encapsulate the sensor with hot melt adhesive or sealant whose curing temperature is higher than 80℃;
- All electrochemical sensors cannot be used or stored in an environment containing corrosive gas, which can damage the sensor;
- The sensor intake passage must not be blocked or polluted;
- When the sensor is not in use, the two poles need to be short-circuited to prevent electrode polarization;

Zhengzhou Winsen Electronics Technology Co., Ltd

Add.: NO.299 Jin Suo Road, National Hi-Tech Zone,
Zhengzhou, 450001 China

E-mail:sales@winsensor.com

Website: www.winsen-sensor.com

Attachment

Attached 1 schematic diagram of sensor application circuit

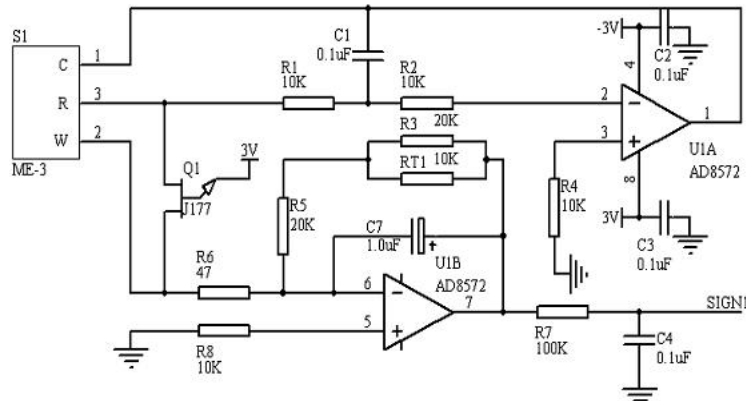

Attached 2 typical curves of sensor characteristics

Figure 1: The sensitivity and response recovery of the sensor

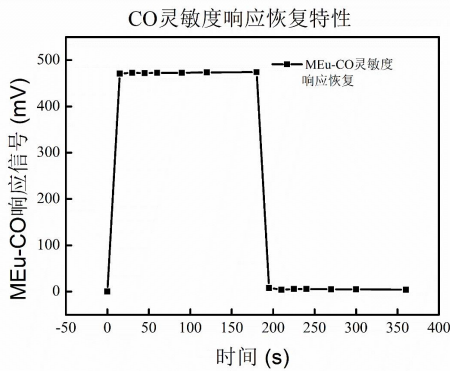

Figure 3: The output of the sensor at different temperatures

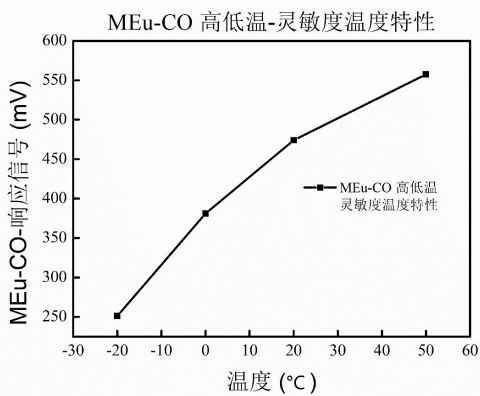

Figure 2: Sensor linearity curve

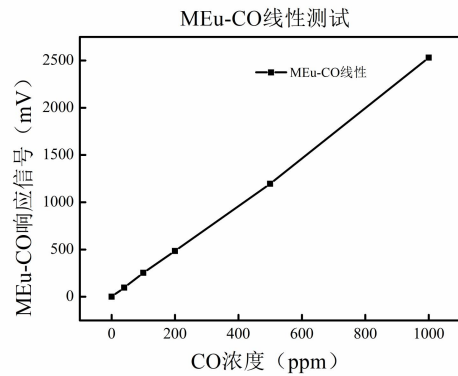

Figure 4: The zero point output of the sensor under different temperature conditions

