



# Alcohol Gas Sensor

(Model: MP-3B)

# Manual

Version: 1.4

Valid from: 2016-12-20

Zhengzhou Winsen Electronics Technology Co., Ltd

# Statement

This manual copyright belongs to Zhengzhou Winsen Electronics Technology Co., LTD. Without the written permission, any part of this manual shall not be copied, translated, stored in database or retrieval system, also can't spread through electronic, copying, record ways.

Thanks for purchasing our product. In order to let customers use it better and reduce the faults caused by misuse, please read the manual carefully and operate it correctly in accordance with the instructions. If users disobey the terms or remove, disassemble, change the components inside of the sensor, we shall not be responsible for the loss.

The specific such as color, appearance, sizes &etc, please in kind prevail.

We are devoting ourselves to products development and technical innovation, so we reserve the right to improve the products without notice. Please confirm it is the valid version before using this manual. At the same time, users' comments on optimized using way are welcome.

Please keep the manual properly, in order to get help if you have questions during the usage in the future.

Zhengzhou Winsen Electronics Technology CO., LTD.

## MP-3B Flat Suraced Alcohol Sensor

MP-3B model with advanced planar construction is comprised of heater and metal oxide semiconductor material of subminiature  $Al_2O_3$  ceramic plate, fetch out electrode down-lead, encapsulation in metal base and cap. When the target gas (alcohol) exists , The sensor's conductivity is more higher along with the gas concentration rising. Please use simple electrocircuit, Convert change of conductivity to correspond output signal of gas concentration.

### Features:

- \* Lower consumption
- \* Small size
- \* Fast response and resume
- \* Highest sensitivity
- \* Excellent stability and long life
- \* Easy circuit and big signal output
- \* Excellent selectivity

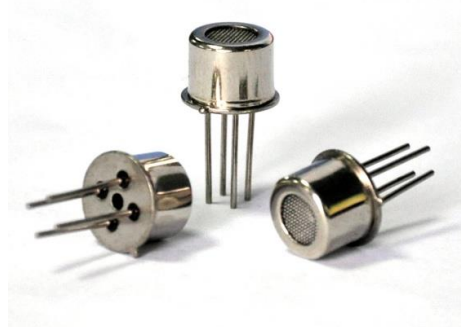

### Application

It is used for detecting whether the driver and other people who drink alcohol, or detecting whether ethanol steamy exist in other places.

### Technical Parameters

Model		MP-3B	
Sensor Type		Flat surfaced semiconductor	
Standard Encapsulation		Metal cap	
Target Gas		Alcohol gas	
Detection range		0~500ppm alcohol	
Standard Circuit Conditions	Loop Voltage	$V_c$	$\leq 24V$ DC
	Heater Voltage	$V_H$	$2.5V \pm 0.1V$ AC or DC
	Load Resistance	$R_L$	Adjustable
Sensor character under standard test conditions	Heater Resistance	$R_H$	$23.5\Omega \pm 4.5\Omega$ (room tem.)
	Heater consumption	$P_H$	$\leq 350mW$
	Resistance of sensitive material	$R_S$	$5K\Omega \sim 50K\Omega$ (in 50ppm $C_2H_5OH$ )
	Sensitivity	$S$	$R_0(\text{in air})/R_S(50ppm C_2H_5OH) \geq 3$
	Concentration Slope	$\alpha$	$\leq 0.6(R_{300ppm}/R_{50ppm} C_2H_5OH)$
Standard test conditions	Tem. Humidity	$22^\circ C \pm 2^\circ C$ ; $55\% \pm 5\% RH$	
	Standard test circuit	$V_c: 2.5V \pm 0.1V$ $V_H: 2.5V \pm 0.1V$	
	Preheat time	Not less than 48 hours	

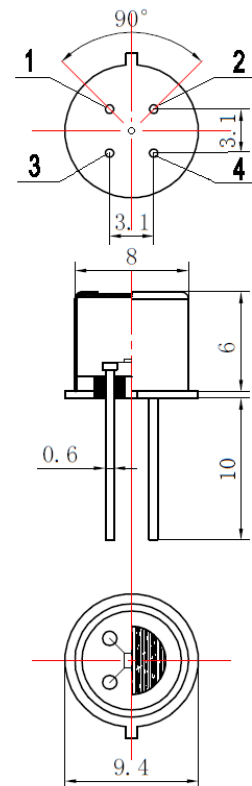

### Basic circuit

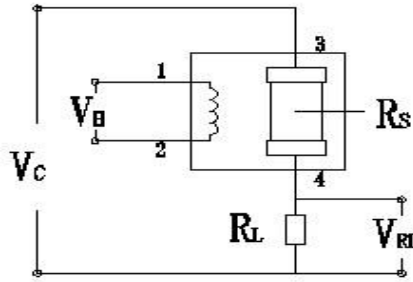

This circuit shows the basic measuring circuit of sensor. Two voltage should be applied to this sensor, heating voltage ( $V_H$ ) and circuit voltage( $V_C$ ).  $V_H$  is used for supplying a certain temperature and  $V_C$  is used for testing the voltage( $V_{RL}$ ) of load resistance( $R_L$ ) that connect to the sensor in series. Due to the tight polarity of sensor,  $V_C$  should be used in DC. Also, $V_C$  and  $V_H$  could share one power supply circuit if it can meet the electronic characteristic of sensor. In order to make better use of sensor, a proper  $R_L$  is very important.

### Characterization

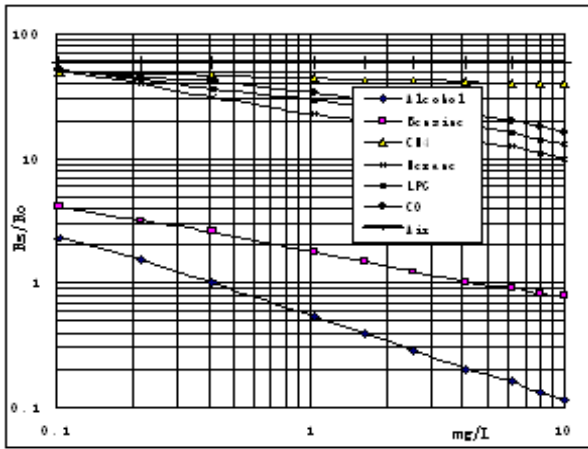

Typical Sensitivity Curve

The ordinate is resistance ratio of the sensor ( $R_s/R_0$ ), the abscissa is concentration of gases.  $R_s$  means resistance in 0.4mg/L alcohol gas,  $R_0$  means resistance of sensor in clean air. All tests are finished under standard test conditions.

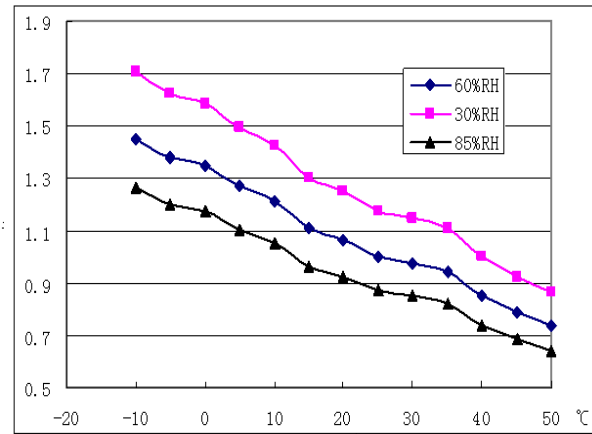

Typical temperature/humidity characteristics

$R_s$  means resistance of sensor in 400ppm alcohol( $C_2H_5OH$ ) under different tem. and humidity.  $R_{s0}$  means resistance of the sensor in 400ppm alcohol( $C_2H_5O$ ) under 20°C/65%RH.

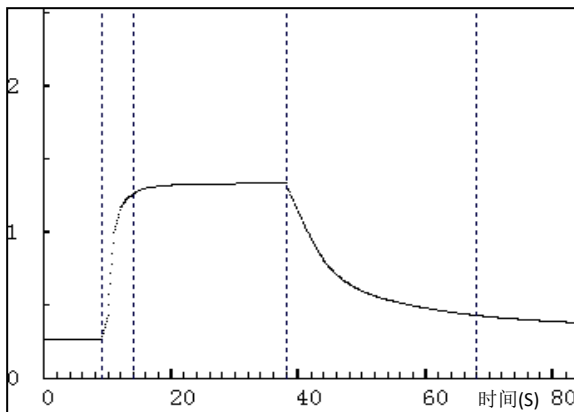

Response and Resume

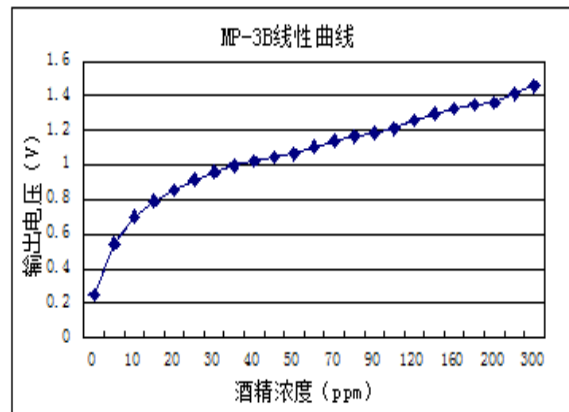

Linear curve

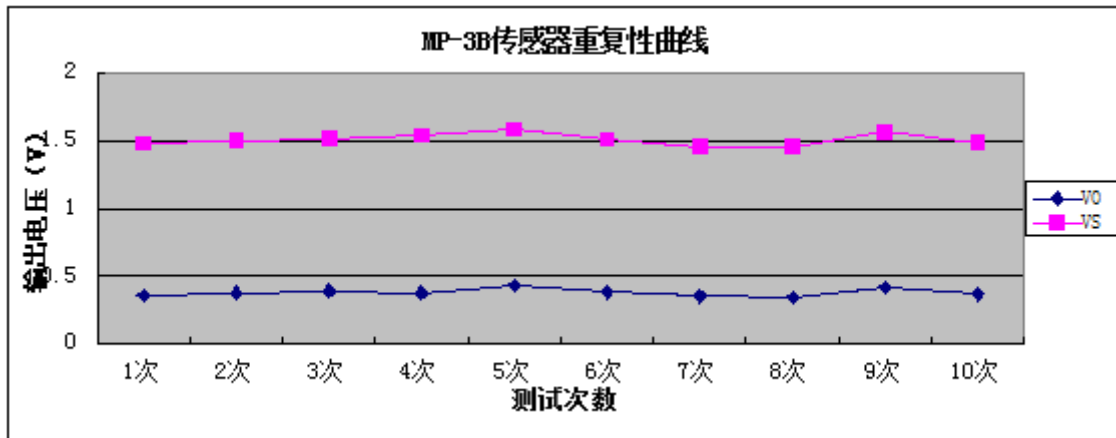

### Long-term Stability

NOTE: Test is finished in standard test conditions, the abscissa is observing time (test every other five minutes) and the ordinate is  $V_{RL}$ .

## Cautions

### 1. Following conditions must be prohibited

#### 1.1 Exposed to volatilizable organic silicon steam

Sensing material will lose sensitivity and never recover if the sensor absorbs organic silicon steam. Sensors must be avoid exposing to silicon bond, fixture, silicon latex, putty or plastic contain silicon environment.

#### 1.2 High Corrosive gas

If the sensors are exposed to high concentration corrosive gas (such as  $H_2S$ ,  $SO_x$ ,  $Cl_2$ ,  $HCl$  etc.), it will not only result in corrosion of sensors structure, also it cause sincere sensitivity attenuation.

#### 1.3 Alkali, Alkali metals salt, halogen pollution

The sensors performance will be changed badly if sensors be sprayed polluted by alkali metals salt especially brine, or be exposed to halogen such as fluorine.

#### 1.4 Touch water

Sensitivity of the sensors will be reduced when spattered or dipped in water.

#### 1.5 Freezing

Do avoid icing on sensor's surface, otherwise sensing material will be broken and lost sensitivity.

#### 1.6 Applied higher voltage

Applied voltage on sensor should not be higher than stipulated value, even if the sensor is not physically damaged or broken, it causes down-line or heater damaged, and bring on sensors' sensitivity characteristic changed badly.

#### 1.7 Voltage on wrong pins

As Fig8, Pin 1&2 connects to heater circuit, Pin 3&4 connects to measuring circuit; Under the requested conditions, heating and measuring can use the same power circuit.

NOTE: the two pins near the protuberance mark is heating electrode.

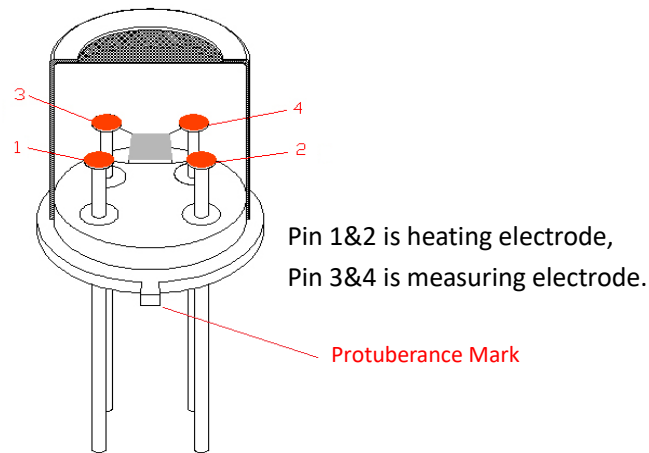

**Fig8.Pin Schematic Diagram**

## 2 .Following conditions should be avoided

### 2.1 Water Condensation

Indoor conditions, slight water condensation will influence sensors' performance lightly. However, if water condensation on sensors surface and keep a certain period, sensors' sensitive will be decreased.

### 2.2 Used in high gas concentration

No matter the sensor is electrified or not, if it is placed in high gas concentration for long time, sensors characteristic will be affected. If lighter gas sprays the sensor, it will cause extremely damage.

### 2.3 Long time storage

The sensors resistance will drift reversibly if it's stored for long time without electrify, this drift is related with storage conditions. Sensors should be stored in airproof bag without volatile silicon compound. For the sensors with long time storage but no electrify, they need long galvanical aging time for stability before using. The suggested aging time as follow:

**Stable2.**

Storage Time	Suggested aging time
Less than one month	Not less than 48 hours
1 ~ 6 months	Not less than 72 hours
More than six months	Not less than 168 hours

### 2.4 Long time exposed to adverse environment

No matter the sensors electrified or not, if exposed to adverse environment for long time, such as high humidity, high temperature, or high pollution etc., it will influence the sensors' performance badly.

### 2.5 Vibration

Continual vibration will result in sensors down-lead response then break. In transportation or assembling line, pneumatic screwdriver/ultrasonic welding machine can lead this vibration.

### 2.6 Concussion

If sensors meet strong concussion, it may lead its lead wire disconnected.

### 2.7 Usage Conditions

2.7.1 For sensor, handmade welding is optimal way. The welding conditions as follow:

- Soldering flux: Rosin soldering flux contains least chlorine
- homothermal soldering iron
- Temperature: 250°C
- Time: less than 3 seconds

2.7.2 If users choose wave-soldering, the following conditions should be obey:

- Soldering flux: Rosin soldering flux contains least chlorine
- Speed: 1-2 Meter/ Minute
- Warm-up temperature: 100±20°C
- Welding temperature: 250±10°C
- One time pass wave crest welding machine

If disobey the above using terms, sensors sensitivity will be reduced.

**Zhengzhou Winsen Electronics Technology Co., Ltd**

**Add:** No.299, Jinsuo Road, National Hi-Tech Zone,  
Zhengzhou 450001 China

**Tel:** +86-371-67169097/67169670

**Fax:** +86-371-60932988

**E-mail:** [sales@winsensor.com](mailto:sales@winsensor.com)

**Website:** [www.winsen-sensor.com](http://www.winsen-sensor.com)